

GUIDE LINE FOR AIRCRAFT WARNING LIGHTS & MARKINGS

CHAPTER 6. VISUAL AIDS FOR DENOTING OBSTACLES

6.1 Objects to be marked and/or lighted

Note.— The marking and/or lighting of obstacles is intended to reduce hazards to aircraft by indicating the presence of the obstacles. It does not necessarily reduce operating limitations which may be imposed by an obstacle.

6.1.1 Recommendation.— *A fixed obstacle that extends above a take-off climb surface within 3 000 m of the inner edge of the take-off climb surface should be marked and, if the runway is used at night, lighted, except that:*

- a) *such marking and lighting may be omitted when the obstacle is shielded by another fixed obstacle;*
- b) *the marking may be omitted when the obstacle is lighted by medium-intensity obstacle lights, Type A, by day and its height above the level of the surrounding ground does not exceed 150 m;*
- c) *the marking may be omitted when the obstacle is lighted by high-intensity obstacle lights by day; and*
- d) *the lighting may be omitted where the obstacle is a lighthouse and an aeronautical study indicates the lighthouse light to be sufficient.*

6.1.2 Recommendation.— *A fixed object, other than an obstacle, adjacent to a take-off climb surface should be marked and, if the runway is used at night, lighted if such marking and lighting is considered necessary to ensure its avoidance, except that the marking may be omitted when:*

- a) *the object is lighted by medium-intensity obstacle lights, Type A, by day and its height above the level of the surrounding ground does not exceed 150 m; or*
- b) *the object is lighted by high-intensity obstacle lights by day;*

6.1.3 A fixed obstacle that extends above an approach or transitional surface within 3 000 m of the inner edge of the approach surface shall be marked and, if the runway is used at night, lighted, except that:

- a) *such marking and lighting may be omitted when the obstacle is shielded by another fixed obstacle;*
- b) *the marking may be omitted when the obstacle is lighted by medium-intensity obstacle lights, Type A, by day and its height above the level of the surrounding ground does not exceed 150 m;*
- c) *the marking may be omitted when the obstacle is lighted by high-intensity obstacle lights by day; and*
- d) *the lighting may be omitted where the obstacle is a lighthouse and an aeronautical study indicates the lighthouse light to be sufficient.*

6.1.4 Recommendation.— *A fixed obstacle above a horizontal surface should be marked and, if the aerodrome is used at night, lighted except that:*

- a) *such marking and lighting may be omitted when:*
 - 1) *the obstacle is shielded by another fixed obstacle; or*
 - 2) *for a circuit extensively obstructed by immovable objects or terrain, procedures have been established to ensure safe vertical clearance below prescribed flight paths; or*
 - 3) *an aeronautical study shows the obstacle not to be of operational significance;*

- b) *the marking may be omitted when the obstacle is lighted by medium-intensity obstacle lights, Type A, by day and its height above the level of the surrounding ground does not exceed 150 m;*
- c) *the marking may be omitted when the obstacle is lighted by high-intensity obstacle lights by day; and*
- d) *the lighting may be omitted where the obstacle is a lighthouse and an aeronautical study indicates the lighthouse light to be sufficient.*

6.1.5 A fixed object that extends above an obstacle protection surface shall be marked and, if the runway is used at night, lighted.

Note.— See 5.3.5 for information on the obstacle protection surface.

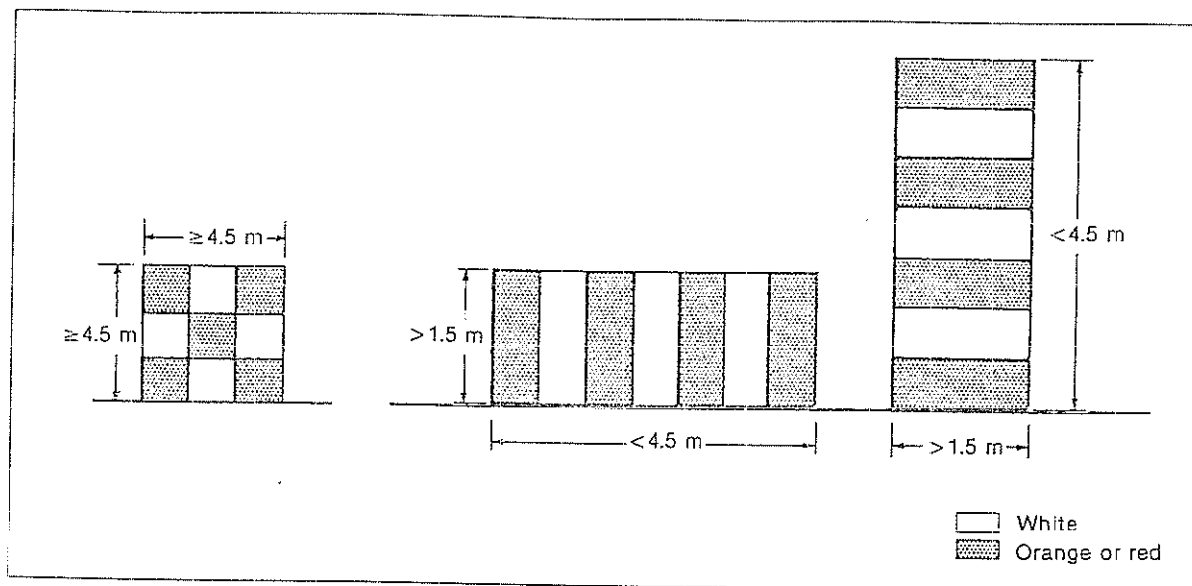

Figure 6-1. Basic marking patterns

6.1.6 Vehicles and other mobile objects, excluding aircraft, on the movement area of an aerodrome are obstacles and shall be marked and, if the vehicles and aerodrome are used at night or in conditions of low visibility, lighted, except that aircraft servicing equipment and vehicles used only on aprons may be exempt.

6.1.7 Elevated aeronautical ground lights within the movement area shall be marked so as to be conspicuous by day. Obstacle lights shall not be installed on elevated ground lights or signs in the movement area.

6.1.8 All obstacles within the distance specified in Table 3-1, column 11 or 12, from the centre line of a taxiway, an apron taxiway or aircraft stand taxiway shall be marked and, if the taxiway, apron taxiway or aircraft stand taxiway is used at night, lighted.

6.1.9 Recommendation.— *Obstacles in accordance with 4.3.2 should be marked and lighted, except that the marking may be omitted when the obstacle is lighted by high-intensity obstacle lights by day.*

6.1.10 Recommendation.— *Overhead wires, cables, etc., crossing a river, valley or highway should be marked and their supporting towers marked and lighted if an aeronautical study indicates that the wires or cables could constitute a hazard to aircraft, except that the marking of the supporting towers may be omitted when they are lighted by high-intensity obstacle lights by day.*

6.1.11 Recommendation.— *When it has been determined that an overhead wire, cable, etc., needs to be marked but it is not practicable to install markers on the wire, cable, etc., then high-intensity obstacle lights, Type B, should be provided on their supporting towers.*

6.2 Marking of objects

General

6.2.1 All fixed objects to be marked shall, whenever practicable, be coloured, but if this is not practicable, markers or flags shall be displayed on or above them, except that objects that are sufficiently conspicuous by their shape, size or colour need not be otherwise marked.

6.2.2 All mobile objects to be marked shall be coloured or display flags.

Use of colours

6.2.3 Recommendation.— *An object should be coloured to show a chequered pattern if it has essentially unbroken surfaces and its projection on any vertical plane equals or exceeds 4.5 m in both dimensions. The pattern should consist of rectangles of not less than 1.5 m and not more than 3 m on a side, the corners being of the darker colour. The colours of the pattern should contrast each with the other and with the background against which they will be seen. Orange and white or alternatively red and white should be used, except where such colours merge with the background. (See Figure 6-1.)*

6.2.4 Recommendation.— *An object should be coloured to show alternating contrasting bands if:*

- a) it has essentially unbroken surfaces and has one dimension, horizontal or vertical, greater than 1.5 m, and the other dimension, horizontal or vertical, less than 4.5 m; or

- b) it is of skeletal type with either a vertical or a horizontal dimension greater than 1.5 m.

The bands should be perpendicular to the longest dimension and have a width approximately 1/7 of the longest dimension or 30 m, whichever is less. The colours of the bands should contrast with the background against which they will be seen. Orange and white should be used, except where such colours are not conspicuous when viewed against the background. The bands on the extremities of the object should be of the darker colour. (See Figures 6-1 and 6-2.)

Note.— Table 6-1 shows a formula for determining band widths and for having an odd number of bands, thus permitting both the top and bottom bands to be of the darker colour.

6.2.5 Recommendation.— An object should be coloured in a single conspicuous colour if its projection on any vertical plane has both dimensions less than 1.5 m. Orange or red should be used, except where such colours merge with the background.

Note.— Against some backgrounds it may be found necessary to use a different colour from orange or red to obtain sufficient contrast.

6.2.6 Recommendation.— When mobile objects are marked by colour, a single conspicuous colour, preferably red or yellowish green for emergency vehicles and yellow for service vehicles should be used.

Table 6-1. Marking band widths

Longest dimension		Band width
Greater than	Not exceeding	
1.5 m	210 m	1/7 of longest dimension
210 m	270 m	1/9 " " "
270 m	330 m	1/11 " " "
330 m	390 m	1/13 " " "
390 m	450 m	1/15 " " "
450 m	510 m	1/17 " " "
510 m	570 m	1/19 " " "
570 m	630 m	1/21 " " "

Use of markers

6.2.7 Markers displayed on or adjacent to objects shall be located in conspicuous positions so as to retain the general definition of the object and shall be recognizable in clear weather from a distance of at least 1 000 m for an object to be viewed from the air and 300 m for an object to be viewed from the ground in all directions in which an aircraft is likely to

approach the object. The shape of markers shall be distinctive to the extent necessary to ensure that they are not mistaken for markers employed to convey other information, and they shall be such that the hazard presented by the object they mark is not increased.

6.2.8 Recommendation.— A marker displayed on an overhead wire, cable, etc., should be spherical and have a diameter of not less than 60 cm.

6.2.9 Recommendation.— The spacing between two consecutive markers or between a marker and a supporting tower should be appropriate to the diameter of the marker, but in no case should the spacing exceed:

- 30 m where the marker diameter is 60 cm progressively increasing with the diameter of the marker to
- 35 m where the marker diameter is 80 cm and further progressively increasing to a maximum of
- 40 m where the marker diameter is of at least 130 cm.

Where multiple wires, cables, etc. are involved, a marker should be located not lower than the level of the highest wire at the point marked.

6.2.10 Recommendation.— A marker should be of one colour. When installed, white and red, or white and orange markers should be displayed alternately. The colour selected should contrast with the background against which it will be seen.

Use of flags

6.2.11 Flags used to mark objects shall be displayed around, on top of, or around the highest edge of, the object. When flags are used to mark extensive objects or groups of closely spaced objects, they shall be displayed at least every 15 m. Flags shall not increase the hazard presented by the object they mark.

6.2.12 Flags used to mark fixed objects shall not be less than 0.6 m square and flags used to mark mobile objects, not less than 0.9 m square.

6.2.13 Recommendation.— Flags used to mark fixed objects should be orange in colour or a combination of two triangular sections, one orange and the other white, or one red and the other white, except that where such colours merge with the background, other conspicuous colours should be used.

6.2.14 Flags used to mark mobile objects shall consist of a chequered pattern, each square having sides of not less than 0.3 m. The colours of the pattern shall contrast each with the other and with the background against which they will be seen. Orange and white or alternatively red and white shall be used, except where such colours merge with the background.

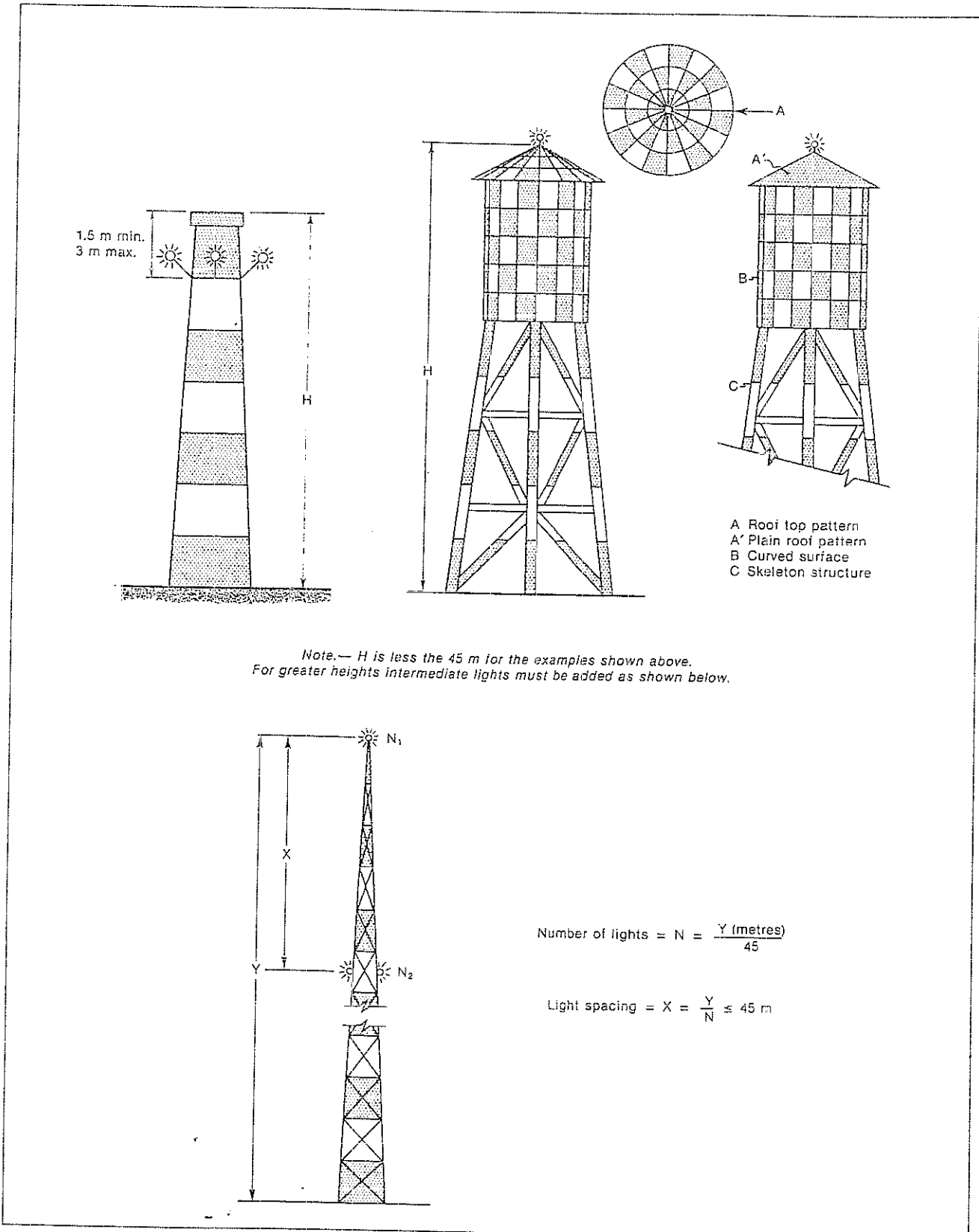

Figure 6-2. Examples of marking and lighting of tall structures

6.3 Lighting of objects

Use of obstacle lights

6.3.1 The presence of objects which must be lighted, as specified in 6.1, shall be indicated by low-, medium- or high-intensity obstacle lights, or a combination of such lights.

Note.— High-intensity obstacle lights are intended for day use as well as night use. Care is needed to ensure that these lights do not create disconcerting dazzle. Guidance on the design, location and operation of high-intensity obstacle lights is given in the Aerodrome Design Manual, Part 4.

6.3.2 **Recommendation.**— Low-intensity obstacle lights, Type A or B, should be used where the object is a less extensive one and its height above the surrounding ground is less than 45 m.

6.3.3 **Recommendation.**— Where the use of low-intensity obstacle lights, Type A or B, would be inadequate or an early special warning is required, then medium- or high-intensity obstacle lights should be used.

6.3.4 Low-intensity obstacle lights, Type C, shall be displayed on vehicles and other mobile objects excluding aircraft.

6.3.5 Low-intensity obstacle lights, Type D, shall be displayed on follow-me vehicles.

6.3.6 **Recommendation.**— Low-intensity obstacle lights, Type B, should be used either alone or in combination with medium-intensity obstacle lights, Type B, in accordance with 6.3.7.

6.3.7 **Recommendation.**— Medium-intensity obstacle lights, Type A, B or C, should be used where the object is an extensive one or its height above the level of the surrounding ground is greater than 45 m. Medium-intensity obstacle lights, Types A and C, should be used alone, whereas medium-intensity obstacle lights, Type B, should be used either alone or in combination with low-intensity obstacle lights, Type B.

Note.— A group of trees or buildings is regarded as an extensive object.

6.3.8 **Recommendation.**— High-intensity obstacle lights, Type A, should be used to indicate the presence of an object if its height above the level of the surrounding ground exceeds 150 m and an aeronautical study indicates such lights to be essential for the recognition of the object by day.

6.3.9 **Recommendation.**— High-intensity obstacle lights, Type B, should be used to indicate the presence of a tower supporting overhead wires, cables, etc., where:

a) an aeronautical study indicates such lights to be essential for the recognition of the presence of wires, cables, etc.; or

b) it has not been found practicable to install markers on the wires, cables, etc.

6.3.10 **Recommendation.**— Where, in the opinion of the appropriate authority, the use of high-intensity obstacle lights, Type A or B, or medium-intensity obstacle lights, Type A, at night may dazzle pilots in the vicinity of an aerodrome (within approximately 10 000 m radius) or cause significant environmental concerns, a dual obstacle lighting system should be provided. This system should be composed of high-intensity obstacle lights, Type A or B, or medium-intensity obstacle lights, Type A, as appropriate, for daytime and twilight use and medium-intensity obstacle lights, Type B or C, for night-time use.

Location of obstacle lights

Note.— Recommendations on how a combination of low-, medium-, and/or high-intensity lights on obstacles should be displayed are given in Appendix 6.

6.3.11 One or more low-, medium- or high-intensity obstacle lights shall be located as close as practicable to the top of the object. The top lights shall be so arranged as to at least indicate the points or edges of the object highest in relation to the obstacle limitation surface.

6.3.12 **Recommendation.**— In the case of chimney or other structure of like function, the top lights should be placed sufficiently below the top so as to minimize contamination by smoke etc. (see Figures 6-2 and 6-3).

6.3.13 In the case of a tower or antenna structure indicated by high-intensity obstacle lights by day with an appurtenance, such as a rod or an antenna, greater than 12 m where it is not practicable to locate a high-intensity obstacle light on the top of the appurtenance, such a light shall be located at the highest practicable point and, if practicable, a medium-intensity obstacle light, Type A, mounted on the top.

6.3.14 In the case of an extensive object or of a group of closely spaced objects, top lights shall be displayed at least on the points or edges of the objects highest in relation to the obstacle limitation surface, so as to indicate the general definition and the extent of the objects. If two or more edges are of the same height, the edge nearest the landing area shall be marked. Where low-intensity lights are used, they shall be spaced at longitudinal intervals not exceeding 45 m. Where medium-intensity lights are used, they shall be spaced at longitudinal intervals not exceeding 900 m.

6.3.15 **Recommendation.**— When the obstacle limitation surface concerned is sloping and the highest point above the

obstacle limitation surface is not the highest point of the object, additional obstacle lights should be placed on the highest point of the object.

6.3.16 Where an object is indicated by medium-intensity obstacle lights, Type A, and the top of the object is more than 105 m above the level of the surrounding ground or the elevation of tops of nearby buildings (when the object to be marked is surrounded by buildings), additional lights shall be provided at intermediate levels. These additional intermediate lights shall be spaced as equally as practicable, between the top lights and ground level or the level of tops of nearby buildings, as appropriate, with the spacing not exceeding 105 m (see 6.3.7).

6.3.17 Where an object is indicated by medium-intensity obstacle lights, Type B, and the top of the object is more than 45 m above the level of the surrounding ground or the elevation of tops of nearby buildings (when the object to be marked is surrounded by buildings), additional lights shall be provided at intermediate levels. These additional intermediate lights shall be alternately low-intensity obstacle lights, Type B, and medium-intensity obstacle lights, Type B, and shall be spaced as equally as practicable between the top lights and ground level or the level of tops of nearby buildings, as appropriate, with the spacing not exceeding 52 m.

6.3.18 Where an object is indicated by medium-intensity obstacle lights, Type C, and the top of the object is more than 45 m above the level of the surrounding ground or the elevation of tops of nearby buildings (when the object to be marked is surrounded by buildings), additional lights shall be provided at intermediate levels. These additional intermediate

lights shall be spaced as equally as practicable, between the top lights and ground level or the level of tops of nearby buildings, as appropriate, with the spacing not exceeding 52 m.

6.3.19 Where high-intensity obstacle lights, Type A, are used, they shall be spaced at uniform intervals not exceeding 105 m between the ground level and the top light(s) specified in 6.3.11 except that where an object to be marked is surrounded by buildings, the elevation of the tops of the buildings may be used as the equivalent of the ground level when determining the number of light levels.

6.3.20 Where high-intensity obstacle lights, Type B, are used, they shall be located at three levels:

- at the top of the tower;
- at the lowest level of the catenary of the wires or cables; and
- at approximately midway between these two levels.

Note.— In some cases, this may require locating the lights off the tower.

6.3.21 Recommendation.— The installation setting angles for high-intensity obstacle lights, Types A and B, should be in accordance with Table 6-2.

6.3.22 The number and arrangement of low-, medium- or high-intensity obstacle lights at each level to be marked shall be such that the object is indicated from every angle in azimuth. Where a light is shielded in any direction by another part of the object, or by an adjacent object, additional lights shall be provided on that object in such a way as to retain the

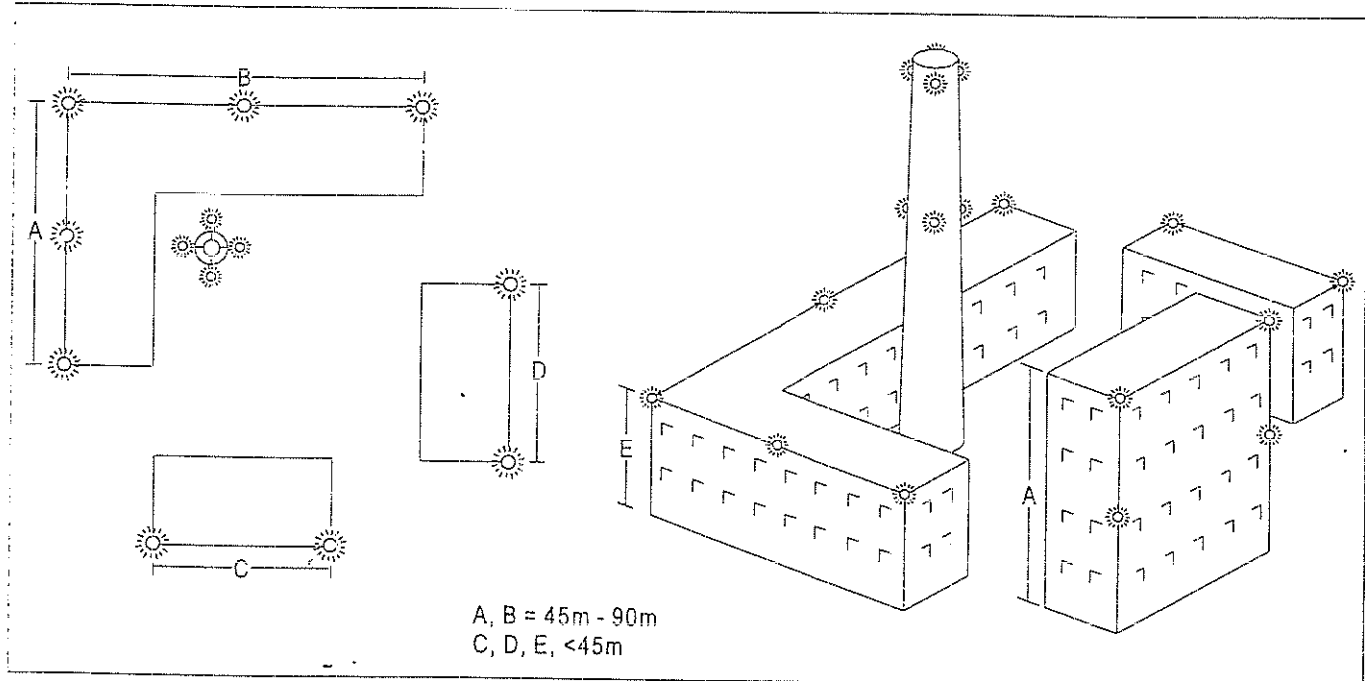

Figure 6-3. Lighting of buildings

general definition of the object to be lighted. If the shielded light does not contribute to the definition of the object to be lighted, it may be omitted.

Table 6-2. Installation setting angles for high-intensity obstacle lights

Height of light unit above terrain	Angle of the peak of the beam above the horizontal
greater than 151 m AGL	0°
122 m to 151 m AGL	1°
92 m to 122 m AGL	2°
less than 92 m AGL	3°

Low-intensity obstacle light — Characteristics

6.3.23 Low-intensity obstacle lights on fixed objects, Types A and B, shall be fixed-red lights.

6.3.24 Low-intensity obstacle lights, Types A and B, shall be in accordance with the specifications in Table 6-3.

6.3.25 Low-intensity obstacle lights, Type C, displayed on vehicles associated with emergency or security shall be flashing-blue and those displayed on other vehicles shall be flashing-yellow.

6.3.26 Low-intensity obstacle lights, Type D, displayed on follow-me vehicles shall be flashing-yellow.

6.3.27 Low-intensity obstacle lights, Types C and D, shall be in accordance with the specifications in Table 6-3.

6.3.28 Low-intensity obstacle lights on objects with limited mobility such as aerobridges shall be fixed-red. The intensity of the lights shall be sufficient to ensure conspicuity considering the intensity of the adjacent lights and the general levels of illumination against which they would normally be viewed.

Note.— See Annex 2 for lights to be displayed by aircraft.

6.3.29 Low-intensity obstacle lights on objects with limited mobility shall as a minimum be in accordance with the specifications for low-intensity obstacle lights, Type A, in Table 6-3.

Medium-intensity obstacle light — Characteristics

6.3.30 Medium-intensity obstacle lights, Type A, shall be flashing-white lights, Type B shall be flashing-red lights and Type C shall be fixed-red lights.

6.3.31 Medium-intensity obstacle lights, Types A, B and C, shall be in accordance with the specifications in Table 6-3.

6.3.32 Medium-intensity obstacle lights, Types A and B, located on an object shall flash simultaneously.

High-intensity obstacle light — Characteristics

6.3.33 High-intensity obstacle lights, Types A and B, shall be flashing-white lights.

6.3.34 High-intensity obstacle lights, Types A and B, shall be in accordance with the specifications in Table 6-3.

6.3.35 High-intensity obstacle lights, Type A, located on an object shall flash simultaneously.

6.3.36 Recommendation.— *High-intensity obstacle lights, Type B, indicating the presence of a tower supporting overhead wires, cables, etc., should flash sequentially; first the middle light, second the top light and last, the bottom light. The intervals between flashes of the lights should approximate the following ratios:*

Flash interval between	Ratio of cycle time
middle and top light	1/13
top and bottom light	2/13
bottom and middle light	10/13.

Table 6-3. Characteristics of obstacle lights

1	2	3	4		5	6	7	8				11	12
			Peak intensity (cd) at given Background Luminance					Intensity (cd) at given Elevation Angles when the light unit is levelled (d)					
Light Type	Colour	Signal type/ (flash rate)	Above 500 cd/m ²	Below 50 cd/m ²	Vertical Beam Spread (c)	-10° (c)	±0° (f)	+6°	+10°				
Low-intensity, Type A (fixed obstacle)	Red	Fixed	N/A	10 mm	10°	—	—	10 mm (g)	10 mm (g)				
Low-intensity, Type B (fixed obstacle)	Red	Fixed	N/A	32 mm	10°	—	—	32 mm (g)	32 mm (g)				
Low-intensity, Type C (mobile obstacle)	Yellow/Blue (a)	Flashing (60-90 fpm)	N/A	40 mm (b) 400 max	12° (h)	—	—	—	—				
Low-intensity, Type D Follow-me Vehicle	Yellow	Flashing (60-90 fpm)	N/A	200 mm (b) 400 max	12° (i)	—	—	—	—				
Medium-intensity, Type A	White	Flashing (20-60 fpm)	20 000 (b) ± 25%	2 000 (b) ± 25%	3° mm	3% max	50% mm 75% max	—	—				
Medium-intensity, Type B	Red	Flashing (20-60 fpm)	N/A	N/A	3° mm	—	50% mm 75% max	—	—				
Medium-intensity, Type C	Red	Fixed	N/A	N/A	3° mm	—	50% mm 75% max	—	—				
High-intensity, Type A	White	Flashing (40-60 fpm)	200 000 (b) ± 25%	20 000 (b) ± 25%	3°-7°	3% max	50% mm 75% max	—	—				
High-intensity, Type B	White	Flashing (40-60 fpm)	100 000 (b) ± 25%	20 000 (b) ± 25%	3°-7°	3% max	50% mm 75% max	—	—				

Note.— This table does not include recommended horizontal beam spreads. 6.3.22 requires 360° coverage around an obstacle. Therefore, the number of lights needed to meet this requirement will depend on the horizontal beam spreads of each light as well as the shape of the obstacle. Thus, with narrower beam spreads, more lights will be required.

- a) See 6.3.25
- b) Effective intensity, as determined in accordance with the *Aerodrome Design Manual*, Part 4.
- c) Beam spread is defined as the angle between two directions in a plane for which the intensity is equal to 50% of the lower tolerance value of the intensity shown in columns 4, 5 and 6. The beam pattern is not necessarily symmetrical about the elevation angle at which the peak intensity occurs.
- d) Elevation (vertical) angles are referenced to the horizontal.
- e) Intensity at any specified horizontal radial as a percentage of the actual peak intensity at the same radial when operated at each of the intensities shown in columns 4, 5 and 6.
- f) Intensity at any specified horizontal radial as a percentage of the lower tolerance value of the intensity shown in columns 4, 5 and 6.
- g) In addition to specified values, lights shall have sufficient intensity to ensure conspicuity at elevation angles between ± 0° and 50°.
- h) Peak intensity should be located at approximately 2.5° vertical.
- i) Peak intensity should be located at approximately 17° vertical.

fpm — flashes per minute; N/A — not applicable

APPENDIX 6. LOCATION OF LIGHTS ON OBSTACLES

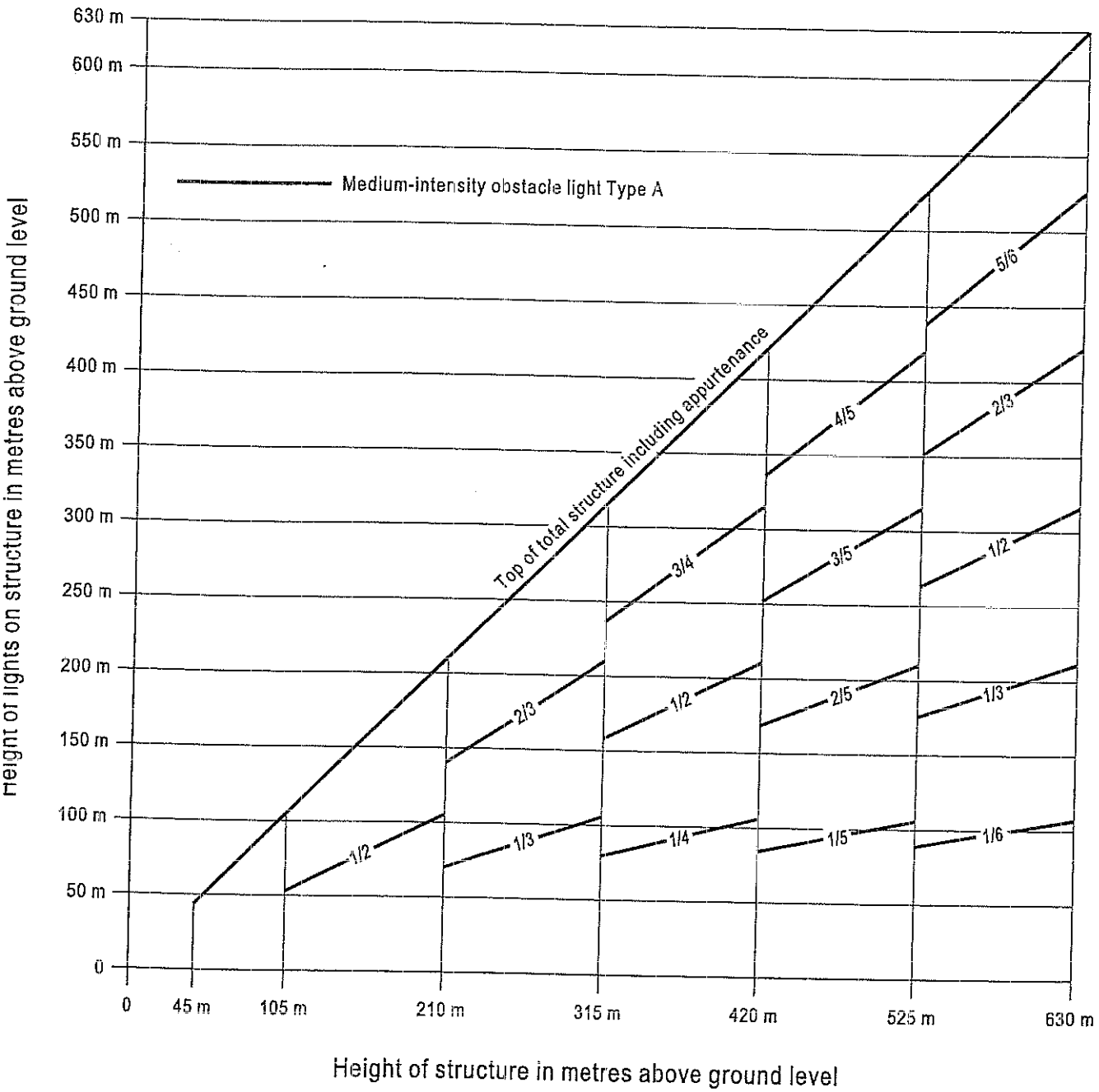

Note.— High-intensity obstacle lighting is recommended on structures with a height of more than 150 m above ground level. If medium-intensity lighting is used, marking will also be required.

Figure 6.1 Medium-intensity flashing-white obstacle lighting system, Type A

pendix 6

Height of lights on structure in metres above ground level

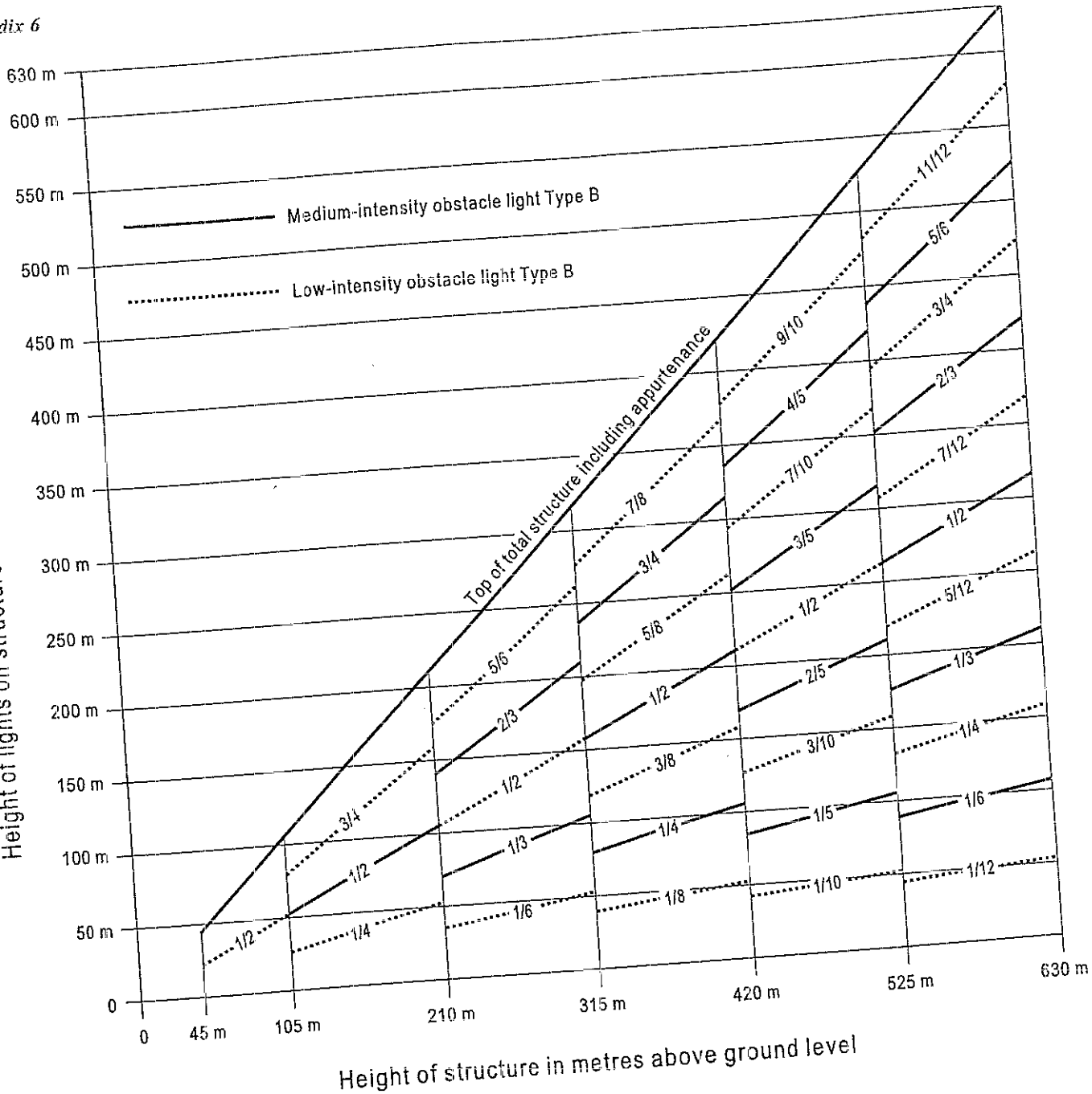

Note.— For night-time use only.

Figure 6.2 Medium-intensity flashing-red obstacle lighting system, Type B

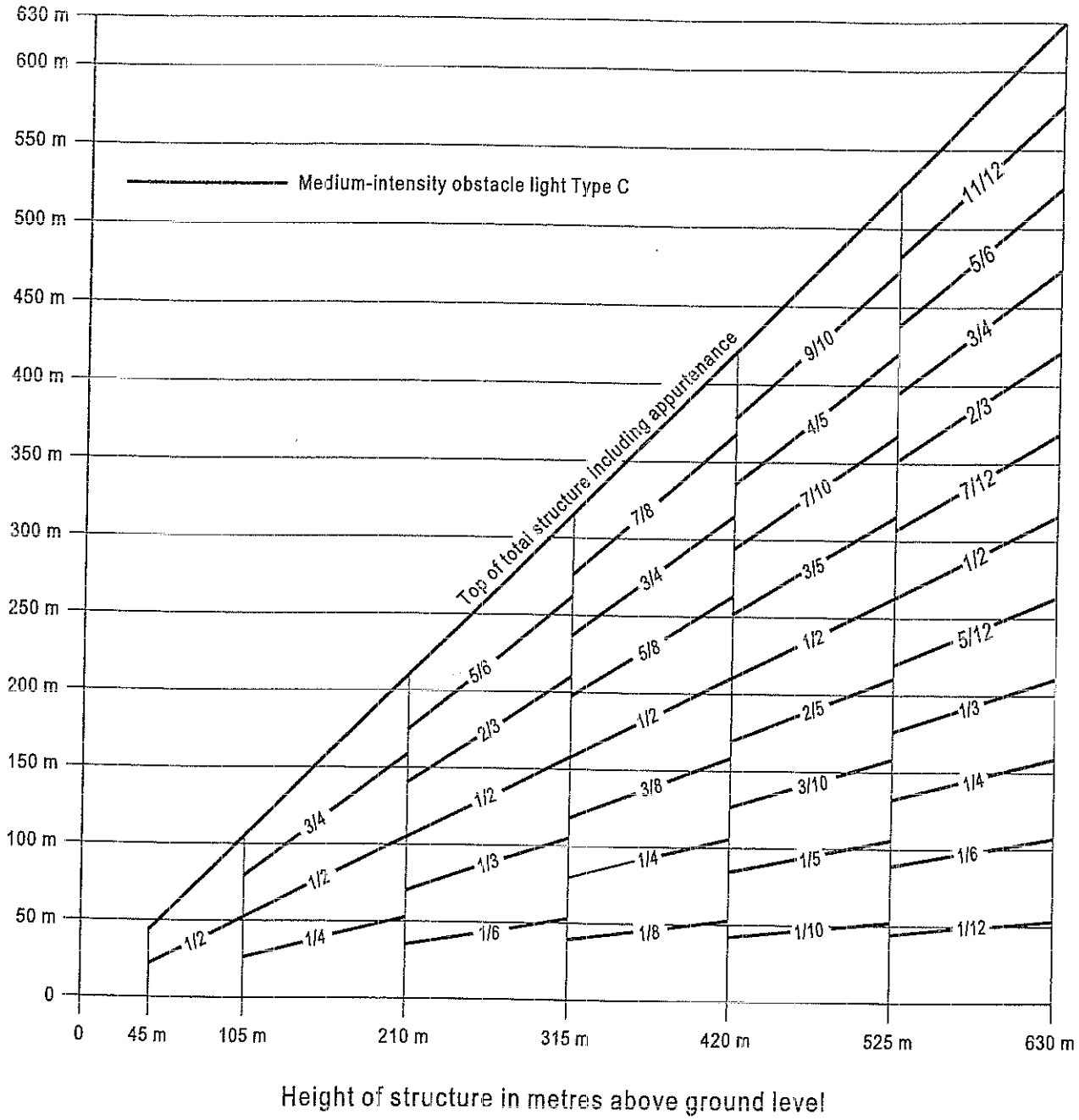

Note.— For night-time use only.

Figure 6.3 Medium-intensity fixed-red obstacle lighting system, Type C

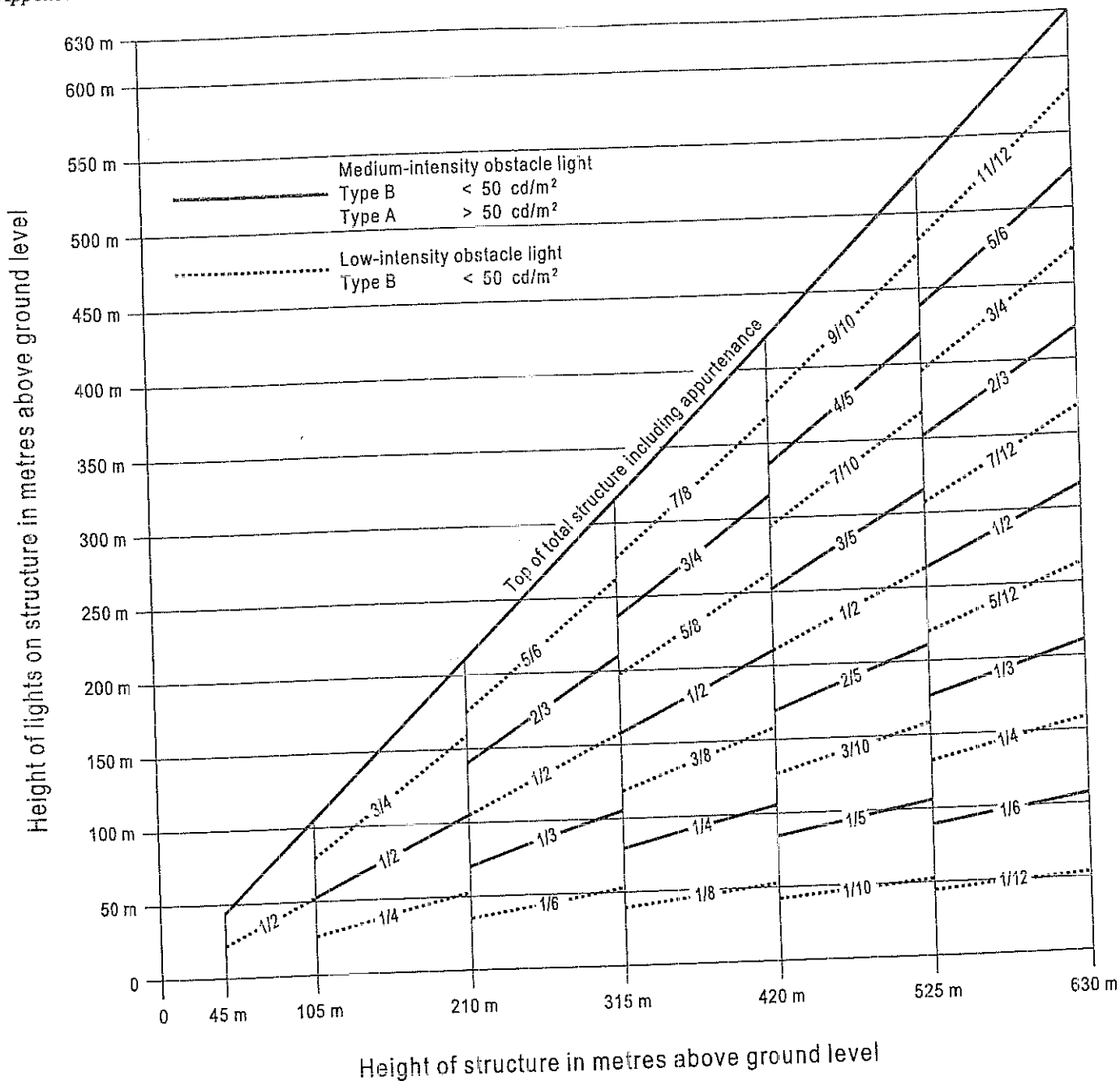

Note.— High-intensity obstacle lighting is recommended on structures with a height of more than 150 m above ground level.
If medium-intensity lighting is used, marking will also be required.

Figure 6.4 Medium-intensity dual obstacle lighting system, Type A/Type B

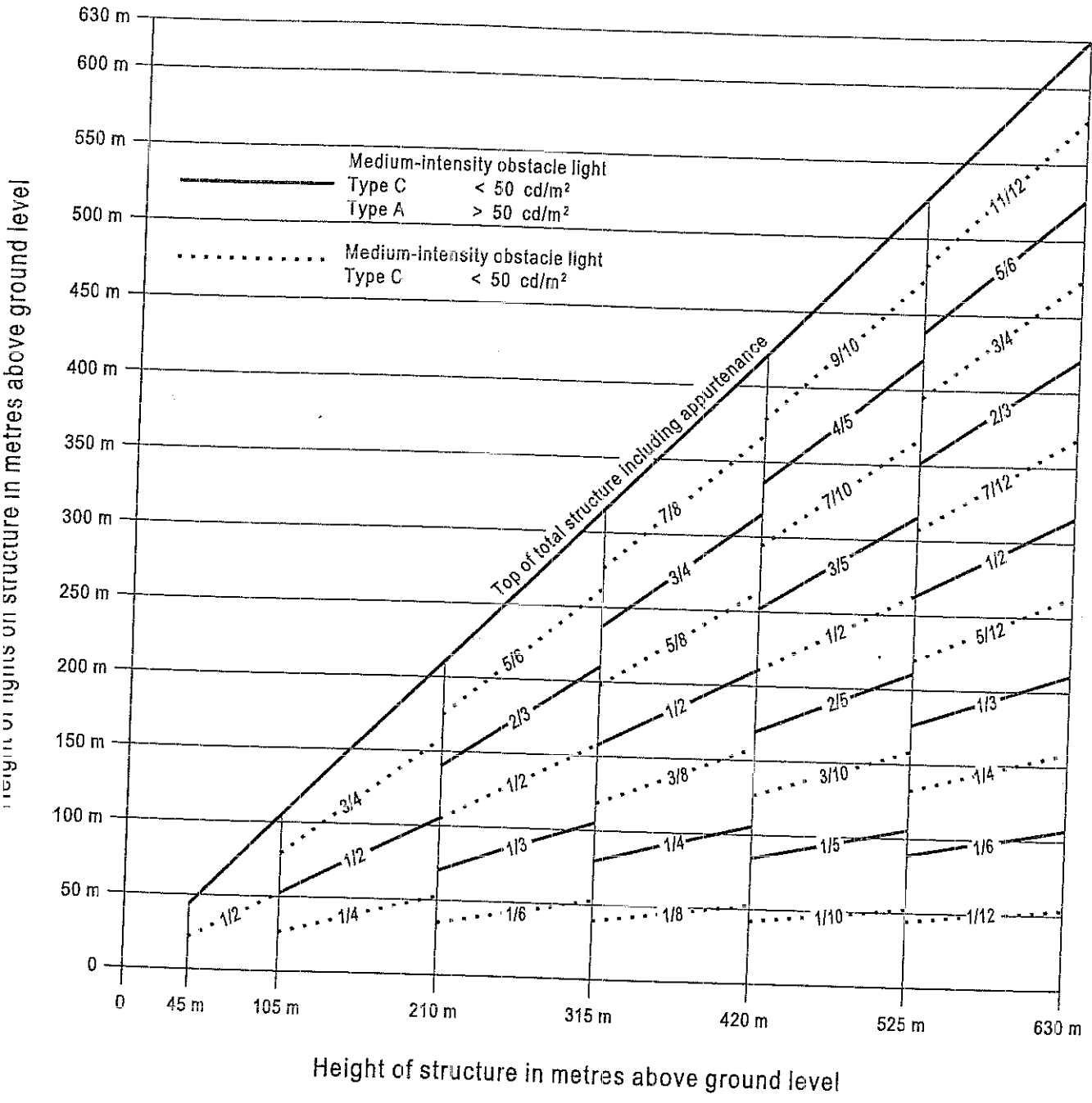

Note.— High-intensity obstacle lighting is recommended on structures with a height of more than 150 m above ground level.
 If medium-intensity lighting is used, marking will also be required.

Figure 6.5 Medium-intensity dual obstacle lighting system, Type A/Type C

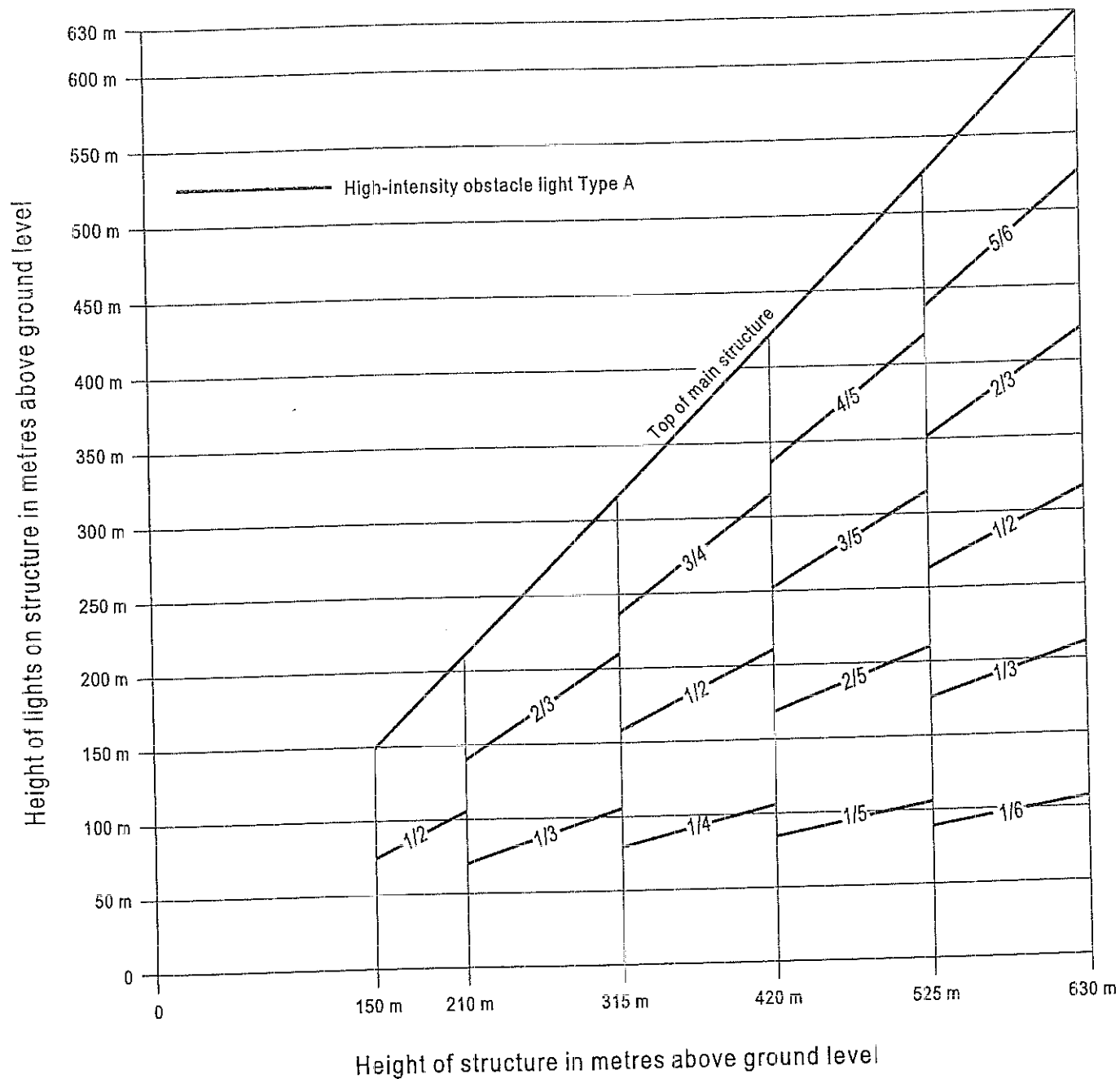

Figure 6.6 High-intensity flashing-white obstacle lighting system, Type A

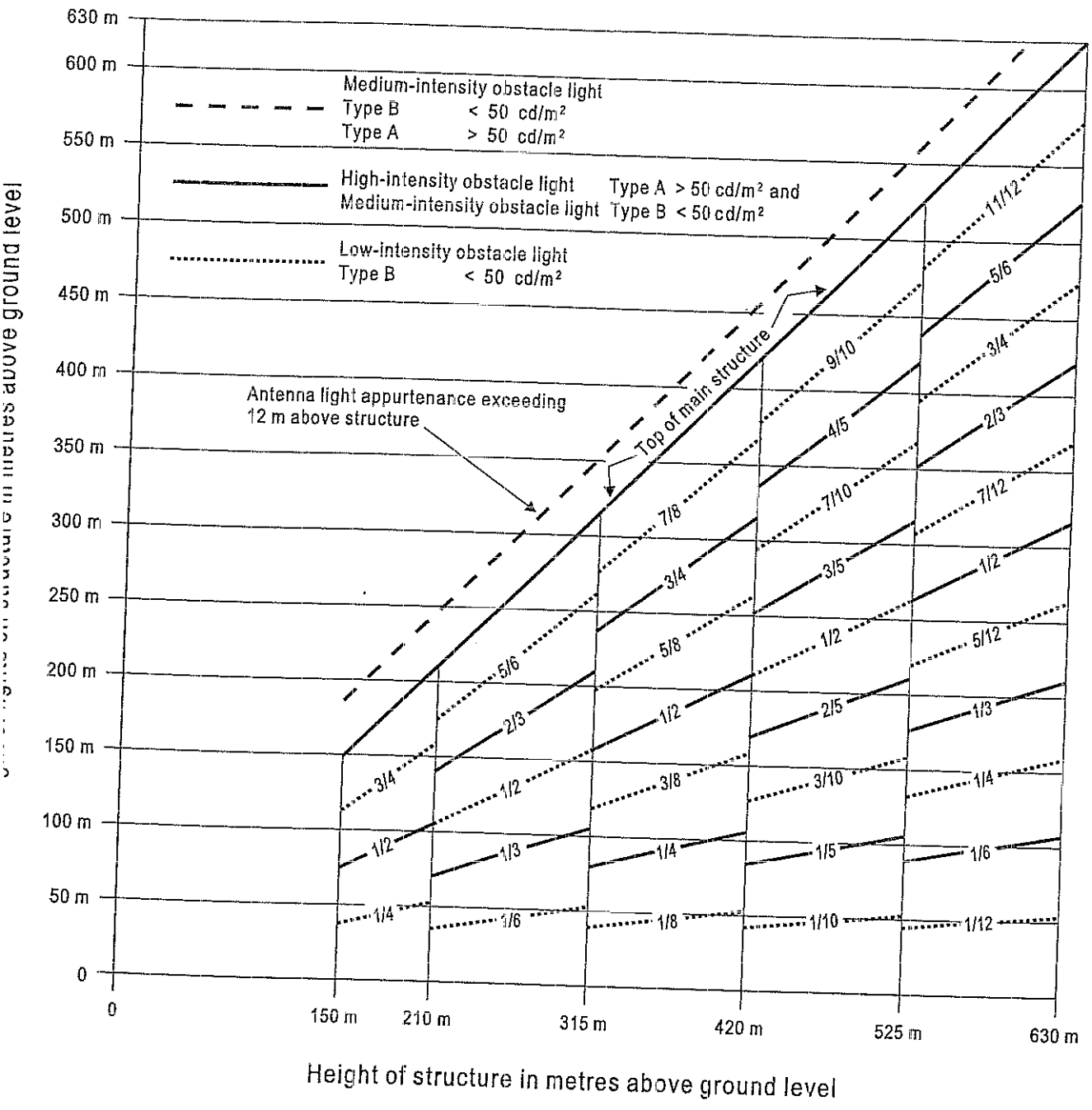

Figure 6.7 High-/medium-intensity dual obstacle lighting system, Type A/Type B

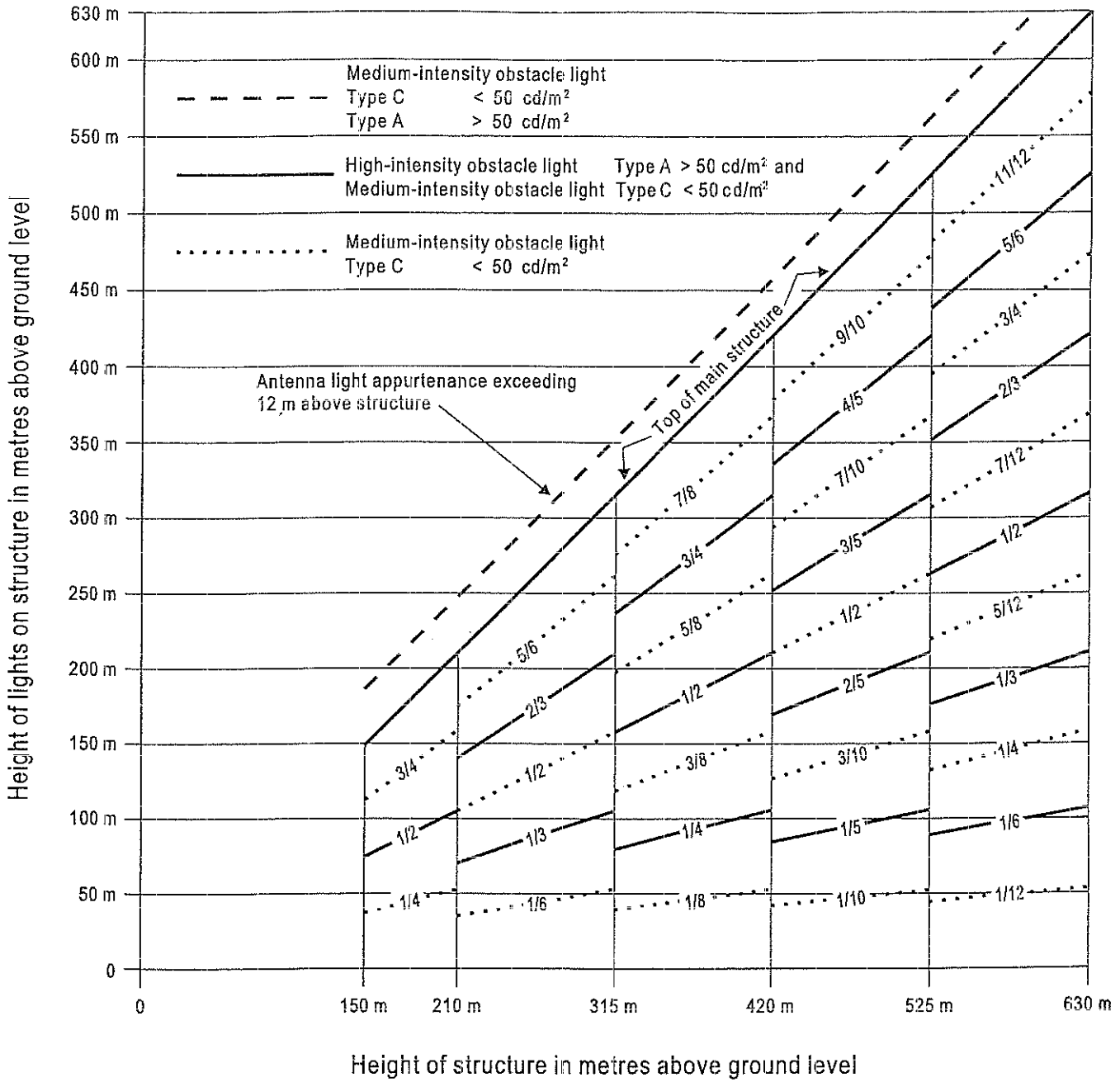

Figure 6.8 High-/medium-intensity dual obstacle lighting system, Type A/Type C